

DESIGN GUIDELINES

Of Bedico Creek Preserve
Longview, Preserve, Lakeview, Preserve III

March 2024

I. INTRODUCTION	1
Purpose.....	1
II. DESIGN GUIDELINES PROCESS.....	2
2.1 Commencement of Construction	2
2.2 Changes and Revisions	2
2.3 Architects and Designers	2
2.4 Design Review Submittal	3
2.5 The Design Review Process.....	3
2.6 Plan Submittal.....	4
2.7 Landscape Plan Submittal.....	5
2.8 Review Fees/Damage Deposits.....	6
2.9 Completion Schedule	6
2.10 Variance Requests.....	6
III. ARCHITECTURAL REQUIREMENTS	6
3.1 Architectural Elements.....	6
3.2 Committee Approval Timeline	6
3.3 Corner Lots	7
3.4 Ceiling Height.....	7
3.5 Setbacks	7
3.6 Drainage/Erosion	7
3.7 Driveways/Walkways	7
3.8 Fence Approvals	8
3.9 Address Numbers/Mailboxes.....	8

3.10 Pools, Spas, Hot Tubs	9
3.11 Satellite Dishes.....	9
3.12 Exterior/Security Lighting	9
3.13 Foundations.....	9
3.14 Fill Requirements.....	9
3.15 Slab Height.....	9
3.16 Exterior Materials/Colors.....	9
3.17 Window Coverings	9
3.18 Windows	10
3.19 Shutters	10
3.20 Roof.....	10
3.21 Ridge Vents.....	10
3.22 Skylights/Solar Collectors	10
3.23 Chimneys/Stack Vents	10
3.24 Garages	10
3.25 Gazebos/Pigeonniers.....	11
3.26 Storage Sheds.....	11
3.27 Servitudes.....	11
3.28 Underground Utilities	11
 IV. SPECIAL DESIGN GUIDELINES.....	 11
4.1 Longview Lots (15-55)	11
4.2 Lakeview Lots (618-623 and 651-676).....	12
 V. LANDSCAPE REQUIREMENTS	 12

5.2 Local Conditions.....	12
5.3 Landscape Design.....	13
5.4 Minimum Landscape Standards.....	13
Recommended Plant Materials.....	15
DESIGN REVIEW APPLICATION.....	20
INSTRUCTIONS FOR DESIGN REVIEW.....	21
EXHIBITS.....	22

DESIGN GUIDELINES
OF
BEDICO CREEK PRESERVE
Revised June 2023

I. INTRODUCTION.

Bedico Creek Preserve is designed to be a unique collection of neighborhoods in one master planned community of homes in western St. Tammany Parish. The natural beauty, quality of open space and quantity of dedicated conservation acreage in an authentic Louisiana setting is an opportunity that escapes all others. The entrance features, parkway layout and neighborhood configurations are all designed so as to take full advantage of these natural amenities. The design of your new home and neighbors is reflected in the materials you select, the placement of landscaping as well as the preservation of existing plant material create a living wild life environment unmatched anywhere on the Northshore. These values along with respect for the natural systems around us drive our commitment to the conservation of this legacy.

1.1 Purpose - Bedico Creek Preserve Subdivision (the “Subdivision”) is a unique collection of neighborhoods in one master planned community each with its own of custom designed homes. To insure the community’s high standards, a plan review process has been established to review all individual building and landscape plans.

The authority to approve, disapprove or recommend modifications to building and landscape plans are provided by the recorded Declaration of Restrictions (the “Declaration”) for the Subdivision. The Declaration does not list specific design items necessary for plan approval but has created the Bedico Creek Owners Association with authority to review and approve or disapprove all individual building and landscape plans.

The Committee is composed of up to five (5) members. Additionally, a professional architect may serve as Chairperson of the Committee, to review and make recommendations with respect to all building. To explain the review process and what is required for plan approval, the Committee has developed these Design Guidelines. The Committee uses these Guidelines to review projects, but may consider individually the merits of any project due to special site conditions. Any project reviewed for special consideration must be shown to benefit the specific site adjacent areas or the Subdivision as a whole.

These Design Guidelines include without limitation, overall house image, scale, proportion and details along with appropriate and reasonable standards for all aspects of design, materials and finishes, such that, overall house image, scale, proportion, details, materials and finishes are desirable, appropriate and of the quality and character which the Committee deems are compatible with the standards and character of the homes in the subdivision, and the Committee may exclude any such overall house images, scale, proportions, details, exterior finishes or

materials which it deems undesirable or which, in its discretion, detracts from the value of the home or the surrounding homes or the general appearance or value of adjacent structures or the neighborhood. The Committee's vision and desires are intended to encourage design creativity that ensures individual yet compatible design character throughout the entire development. While each home design proposed will be reviewed based upon the criteria contained within these Design Guidelines, it is important to acknowledge that each submittal will also be reviewed based upon how well it relates to and supports the overall goal of creating a compatible street scape and fits within the overall neighborhood. It is through understanding and then implementing the desired appropriate character that the quality and value of the overall neighborhood along with the financial investment of each homeowner may be maximized. The Committee will seek to encourage the creation of aesthetically harmonious relationships among the homes within the Subdivision and between the particular lot and home. The Committee will encourage the development of a Subdivision of outstanding architectural statements, and the repetition of home designs will be limited. No Contemporary, Victorian or Spanish styles will be accepted. Only Classic, Time Tested, Regional, Traditional, Historic rural styles will be accepted.

Bedico Creek is made up of numerous neighborhoods, and as such, each neighborhood will have its own set of Design Guidelines.

II. DESIGN GUIDELINES PROCESS

2.1 Commencement of Construction - No residence, building, fence, wall or other improvement or structure shall be commenced, erected or maintained, nor shall any addition, change or alteration of any kind therein be made until properly, professionally prepared plans showing the nature, kind, shape, height, materials, floor plans, elevations, garage door and garage, the grading plan of the lot on which the improvements are to be erected, and such other matters as the Committee may require shall have been submitted to and approved in writing by a majority vote of the Committee and a copy thereof as finally approved lodged permanently with the Committee.

2.2 Changes and Revisions - All changes to final plans or materials must be submitted to the Committee and approved prior to implementation. If a homeowner/builder constructs a home or other structure which is other than that which is approved, including materials, the homeowner/ builder may be responsible for the removal or replacement of the non-conforming construction and/or materials at his own expense.

2.3 Architects and Designers - A pre-approved architect or home designer must be used for construction projects within Bedico Creek. The architects and designers composing the pre-approved list have demonstrated that they understand and are willing to comply with the vision and goals as called for in the Design Guidelines or who in the Committee's opinion have produced previous work which would meet the development's high standards.

You may obtain a copy of the list by contacting the Design Review Coordinator.

Contractors, architects and home designers who are interested in being considered for “approved” status should contact the Design Review Coordinator for a list of required criteria for submittal to be considered for preliminary approval.

Upon submitting qualifications and examples of previous work (documents and photographs of completed work), the request will be considered for preliminary approval.

Upon preliminary approval, the architect or designer will be required to attend a Design Review Orientation Meeting. Final Status will be determined following this meeting.

Approval may be reassessed given cause or annually.

The Committee reserves the right to remove any architect or designer from the approved list. Two examples of cause for removal are: preparation of incomplete design review submittals; repeated submission of designs for approval which do not comply with the appropriate character and detailed requirements as called for in the Design Guidelines.

NOTE: One's ability to draft and produce an industry standard set of home plans is not justification to be added to the approved list.

2.4 Design Review Submittal

The design review submittals are:

- A. Preliminary Design with Site Plan (optional)
- B. Final with Site Plan

Plans must consist of digital files as PDF.

All design reviews shall be based upon compliance with the Design Guidelines and the Restrictive Covenants (available at bedicocreekhoa.com / Password: bhomeowner). It is the Owner’s responsibility to comply with applicable building and zoning codes in effect. The design review process is in no way intended to be used as an analysis for determining errors or omissions in plans and specifications or design defects.

2.5 The Design Review Process – The design review process consists of the following:

1. Select your home designer from the list of Bedico Creek recommended designers.
2. Review the Design Guidelines with your designer.
3. Complete the Design Review Application for submittal with fee and deposits.
4. Submit Plans and Site Plan along with completed application, review fee, and deposits.

5. Revise plans, incorporating the Design Review Committee's comments, if any.
6. Final Plan Submission (digital files)
7. Revise Final plans, incorporating the Design Review Committee's comments, if any.
8. Receive Final Plan approved by the Design Review Committee.
9. Select a Builder (if not already selected)
10. Apply for STP building permit.
11. Begin Construction.
12. Complete home and install landscaping **prior to move in.**
13. Request Final Inspection in writing.
14. Correct any deficiencies.
15. Receive Approval of Design Review Coordinator.
16. Receive Refund of Damage Deposit.

2.6 Plan Submittal - Submittal shall consist of Digital Plans including:

1. Site Plan - The plans must include a site plan with the following information:
 - All proposed structures, fencing, building lines, easements, and set back lines.
 - Proposed slab elevations
 - Drainage plan (culvert size if applicable)
 - All driveway, walkways, paving pads, decks, A/C pads, etc.

2. Floor Plan - Drawn to scale (1/4" = 1 foot.

3. All Building Elevations - All elevations must articulate materials, exterior finishes, windows, shutters, trim, fascia details and other architectural detailing. Dimensions, details and locations of all architectural elements

(For example: Columns, Dormers, Shutters, Chimneys, etc.) must be provided.

4. Floor Plans
5. Roof Plan - must show all roof pitches and all plumbing penetrations or notation that no penetrations are located in the front of the home.
6. Completed Design Review Application
7. Submittal of Home Plan Design Review Fee
8. Submittal of Construction Damage Deposit

Approval or required revisions will be emailed to you.

Any changes to Plans after approval is given must be submitted and approved by the Committee prior to implementation. If a homeowner/builder constructs a home or structure other than that which is approved, he may be required to tear down or remove it at his own expense.

2.7 Landscape Plan Submittal – If requested by Committee, Landscape Plan Submittal shall consist of two full sets of landscape/hardscape plans (drawn to scale 1" '10' minimum) including:

1. Scale of drawing 1" ' 10'
2. Show existing footprint of home
3. Show all existing and proposed hardscapes, ie. Walks, patios, fences, walls, pools and detached structures (pigeonniers and the like)
4. Show existing trees to remain
5. Show drainage swales along property lines and all subsurface drainage. (Indicate direction of flow)
6. Show variety, size, number and location of all plant material (This must be clearly labeled on Plan.)
7. Label areas to be sodded
8. Provide Plant Material List including:
 - a. Quantity
 - b. Botanical Name
 - c. Common Name
 - d. Size
9. Tree Removal plan
10. Provide bed preparation specifications
11. Provide screening details, ie. Lattice, etc.

2.8 Review Fees /Damage Deposits - Damage Deposits and Review Fees must be submitted prior to or with submittal of preliminary plans. Fees and Deposits shall be made payable to: **Bedico Creek Preserve Property Owners Association, Inc.**

2.9 Completion Schedule - Once construction of a residence or any additional or outside structure has commenced it must be completed within twelve (12) months. Thereafter, at the discretion of the Committee up to \$100/day fine will accrue.

2.10 Variance Requests - Variance requests are considered and may be approved on a case by case basis. Prior to petitioning the committee for such a request, petitioner may be required to receive written approval in writing from adjacent property owners.

Review Fees and Deposits (See Design Review Application)

Refunds of Damage Deposit will be made in the following manner. Upon completion of the home, the owner shall request a final inspection of the home in writing. A representative of the Committee then makes an inspection of the home and landscaping. The owner is notified of any items which are in need of correction. Refund of both the deposits is conditioned upon repair of any and all items damaged, completion of all incomplete items, and adherence to all restrictions, within 90 days of home completion. This is evidenced by a satisfactory inspection of the property by an appointee of the Committee. Once the home has received a satisfactory final inspection, the deposits will be refunded within 15 days. Any damage caused by Owner, Owner's contractor or subcontractors will be deducted from the deposit.

III ARCHITECTURAL REQUIREMENTS

3.1. Architectural Elements - Details, including the location, design, proportions and dimensions of Architectural elements, such as, dormers, columns, shutters, finials, stucco bands and quoins, etc., must be submitted to the Committee along with home plans and all specifications. These details and specifications are subject to the approval of the Committee.

A. Square Footage Requirements

<u>Neighborhood</u>	<u>Lots</u>	<u>Section</u>	<u>Min. Sq.Ft. Living Area</u>
Longview	15-55	D-1	1800
Preserve	56-73 & 233-237	D-2	2200
Lakeview	618-623; 651-676	16	2200
Preserve III	624-650	F	2500

3.2. **Committee Approval Timeline** - In the event the Committee fails to approve or disapprove within twenty-one (21) days after any matter, including plans and specifications, has been submitted to it, approval shall not be required by the Committee; however, all other provisions of these restrictions shall continue to apply. This should not imply that plans or design elements which do not comply with architectural standards set forth herein will be considered approved.

3.3. **Corner Lots** - Both elevations facing streets edge must have aesthetically pleasing exteriors.

3.4. **Ceiling Height** - All residences shall be constructed with at least ninety (90%) percent of the ceilings on the ground floor not less than nine (9') feet high.

3.5. **Setbacks** - Unless approved in advance by the Committee and except as otherwise shown on the Final Plat of the Subdivision, front, rear, and side minimum building setback lines shall be as follows:

	Longview	Preserve	Lakeview
Front	20'	30'	20'
Side	5' / Corner 10' min.	8' / Corner 15' min.	5'/Corner 10' min.
Rear	25'	25'	25'

If there is a conflict between the setbacks shown and the final plat, the greater distance should be used.

Any request for variance to setbacks must be made in writing to the Committee and must have Committee approval prior to implementation.

3.6 **Drainage/Erosion** - It shall be the owner/builder's responsibility to see that lots are graded to direct drainage to the street, except for lots which the final plat dictates otherwise. Drainage must be shown on the site plan for approval.

During construction, builders may use silt screen or bails of hay to control erosion and mud flow to streets, walkways and cart paths. During and after construction, erosion shall be controlled by completely sodding exposed slopes. The use of exposed drain pipe or impervious swale lining is prohibited; however, catch basins and buried drain pipe may be used. Each homesite shall have drainage swales along the rear and side property lines sloping toward the street. Lot owners are responsible for maintenance of these swales at all times.

3.7 **Driveways/Walkways** - All driveways must be laid out as per Exhibit A. Driveways shall be constructed no nearer than one (1') foot from the side property line or within 20' of an existing

driveway. Driveways shall be constructed of concrete and shall have a width of not less than eleven (11') feet flaring to a maximum of eighteen (18') feet at street's edge. No driveway shall be permitted adjacent to another except where the configuration of lots dictate it necessary and then it must be approved by the Committee. The placement of driveways shall be in accordance with specifications as shown on Exhibit A. Walkways shall be constructed on each lot consisting of hard surfaced paths leading from the driveway to the front entrance of the home. Walkways shall be minimum of 42" in width. No walks to street are allowed except for corner lots.

The driveways in Longview and Preserve finished grade must allow drainage from lot and adjacent lots to flow to appropriate catch basin.

3.8 **Fence Approvals** - All fence locations and details must be submitted to the Committee for approval prior to construction including details of decorative fences and non-perimeter fences. Existing fence designs located on adjacent lots must be resubmitted to the Committee for approval prior to construction. Gates are considered as part of fences and gate details must be submitted for approval. Chain link or wire fences are prohibited. Brick columns are allowed.

A. **Fences** - Privacy fences shall be constructed of natural cedar or cypress that may be left to weather naturally without any treatment. Fences may be treated with Benjamin Moore clear Arbor Coat which acts as a sealer/preservative due to its water proofing capabilities or Thompson's Water Seal. All board fences must be shadowbox style as shown on Exhibit C and six (6') feet high, boards cannot be dog-eared but must use only wood posts, shadowboxing style with four inch (4") spaces between boards alternating on both sides of the fence and must be built on the property line. Shadowboxing allows for a two sided fence each having an equally finished appearance. Therefore, it is recommended that fence costs be shared by adjoining lot owners. Iron picket, simulated wrought iron fences or anodized or painted aluminum perimeter fences are allowed only on the Greenspace. Iron pickets or wrought iron like (i.e., aluminum) fences must be black and must conform to specifications of spacing, rail heights and post sizes as shown on Exhibit B.

B. Pond lots in Longview (lots 44-55):

- i. Side yard fences for all lots, 44-55 – Shadowbox only
- ii. Rear yard fences for lots 46, 47, 49, 50, 53, 54 – Wrought Iron or aluminum are required (see Exhibit B)
- iii. Rear yard fences for lots 44 – Shadowbox Only
- iv. Rear yard fences for lots 45, 48, 51, 52, 55 – Shadowbox or aluminum

3.9 **Address Numbers/Mailboxes** - Address numbers shall be displayed on mailboxes. The Committee has pre-selected the type and style of mailbox and requires property owners to

select this style for their residence. Mailboxes shall be placed near the sidewalk or driveway close to the center of the lot.

- 3.10 **Pools, Spas, Hot Tubs** - The design and location of pools, spas, and hot tubs shall be subject to the approval of the Committee and shall be harmonious with the architecture and landscape design. Pool fences shall conform to city requirements and the requirements for fencing in these restrictions. The equipment, location and screening will receive close review. No above ground pools are allowed.
- 3.11 **Satellite Dishes** - Service is available in Bedico Creek. The Design Review Committee may allow 18" Satellite dishes under the following conditions. Dishes must be ground mounted or mounted on the house but not visible from the street. The signal must not interfere with the reception of television or radio signals upon any other properties. The Design Review Committee will have the authority to grant or deny any request on a case by case basis.
- 3.12 **Exterior/Security Lighting** - Exterior site lighting and security lighting shall be shielded and not infringe upon adjacent neighbors or any public way. Utility poles shall be prohibited.
- 3.13 **Foundations** - Foundations should be properly designed by a structural engineer, the builder, designer or architect of your home. The Developer does not warrant soil conditions. City Parish regulation should be reviewed carefully for slab elevation requirements. If over 8" of slab is showing, it must be camouflaged by brick ledge or by screening with continuous landscape materials.
- 3.14 **Fill Requirements** – No higher than 12” above grade near slab and 6” above grade for drives and walks.
- 3.15 **Slab Height** – If any slab is 3’ above crown of street, it must have a dropped brick ledge and be submitted for approval. No more than 12” of fill adjacent to slab.
- 3.16 **Exterior Materials/Colors** - The exterior of the home and accessory buildings shall be constructed of stucco, brick or siding approved by the Committee. Fake stone and lava rock are expressly prohibited. All siding must be wood or Hardi cement, smooth single board lap siding subject to the approval of the Committee. The Committee requires the use of subdued, historically correct colors. No bright or strong colors will be allowed. Colors will be examined not only in relation to one another on the subject home, but in relation to other homes within the line of sight. **When in doubt, submit colors in advance for approval. The Committee has the authority to disapprove color choices and force the re-painting of color choices that are not harmonious within the community.** Any changes in exterior colors or materials must be approved by the Committee, as must all changes to plans. Wood beams must be sealed with a clear sealant or naturally weathered.
- 3.17 **Window Coverings** - No foil, sheets, reflective materials, paper, or other inappropriate materials or bright colors shall be used on any windows for drapes, sunscreens, blinds, shades or other purpose on a temporary or permanent basis. For temporary window

coverings, the committee suggests the use of inexpensive shades or blinds until permanent window coverings are installed. Interior window coverings shall be lined in a neutral color so as not to detract from the exterior of the home.

- 3.18 **Windows** - If clad windows are used, appropriate trim (as determined by the committee) must be used. Divided lights shall be vertical or horizontal and required on front elevations or windows viewed from the street unless deemed inappropriate by the Committee. If false dormers are used, appropriate window treatments must be used to prevent interior of attic from being seen or framing must be painted black so as not to be seen from street or obscure glass must be used.
- 3.19 **Shutters** - Shutter width should be proportionate to the window (1/2 the window width). Shutters on front elevations must have cast iron hinges and "S" hooks but do not need to be operable. All shutters must be approved by the Committee. Shutter details must be shown on elevation drawings. Picture windows should not have shutters. Closed shuttered windows shall not have battens showing, but the window shall be framed and the attendant appropriate hardware shall be included. Where wood windows are required; false shutters must have hardware.
- 3.20 **Roof** - The pitch of the main roof should be not less than an 8:12 pitch; minor, inconspicuous or appropriate areas may have a lower pitch. The Committee may approve a lesser pitch if designer can show that it is more appropriate to the proportions of the house. Recommended roof material colors are browns or grays. False shadowline shingles will not be allowed.
- The minimum roof composition requirement in Bedico Creek shall be **composition architecturally cut shingles**. Other roofing materials which may be used are laminated composition architecturally cut shingles, true slate, imitation slate or cedar shake shingles.
- 3.21 **Ridge Vents** - Only English Tiles along roof ridges will be allowed. Turban vents are allowed if used in an inconspicuous location.
- 3.22 **Skylights/Solar Collectors** - **Skylights Solar Collectors are not encouraged**. Skylights shall not be located on the front elevation or portion of the home. Only flat skylights/solar collectors shall be allowed. No bubble skylights will be permitted. Solar collectors may be placed in the rear of homes only. Skylights and solar collectors must be properly located and clearly shown on plans when submitted and must be approved prior to implementation. Details and dimensions must be included in submittal. All skylights must be approved by the committee.
- 3.23 **Chimneys/Stack Vents** - All exposed portions of chimneys must be brick, Hardi board, stucco, or vinyl. All vents must be in rear of the home when possible.
- 3.24 **Garages** - All lots shall have enclosed garages. Garages should be designed to blend with the main home utilizing the same materials and details. Garages shall have a minimum inside clearance of 22'x22'. Garages should be of sufficient size to accommodate a minimum of two and not more than four automobile. All garages must be equipped with

fully operational automatic garage door openers activated by remote control. Garage doors may be constructed of wood or painted metal. Garage doors must be raised panel. All garage doors must remain closed except for ingress and egress. Windows in garages that face the street must have appropriate window treatments (or obscure glass) to screen garage interior from the street. Lots within all Parcels may elect to have front courtyard, side-loading garages subject to the approval of the Committee. Building material above the garage door must be the same as the material on the rest of the garage. (Eg. Brick garages must have brick above the garage door, not siding or stucco.)

- 3.25 **Gazebos/Pigeonniers** - Gazebos, pigeoniers, pergolas and other detached structures should relate architecturally to the design of the home in both form and material. Details and location of all detached structures must be submitted for approval with the landscape plan and must be approved by the Committee.
- 3.26 **Storage Sheds** - Storage sheds must be attached to the home or garage and shall be constructed of the same materials as the residence. No prefab, free-standing structures shall be permitted.
- 3.27 **Servitudes** - Servitudes for installation, maintenance of utilities and drainage facilities are reserved as shown on the final plat of Bedico Creek Subdivision. Overhangs in servitudes will not be allowed without the written consent of the Committee and a copy of approval from the Parish.
- 3.28 **Underground Utilities** - This subdivision will be served by underground utilities only. Electric service from the electric distribution system to a residence must be underground.

IV. SPECIAL DESIGN GUIDELINES

It is the intent of these design guidelines to create a unique high quality neighborhood within the Bedico Creek Community. These guidelines will convey an understanding of the neighborhood vision and required architectural character and detailing for the Property.

These Special Design Guidelines are hereby established as an addition to the Bedico Creek Design Guidelines and Restrictions. Where these Special Design Guidelines are in conflict with the Bedico Creek Design Guidelines and Restrictions, the Special Design Guidelines shall govern.

4.1 Longview Lots (15-55)

- (a) Side yard fences for all lots, 44-55 – Shadowbox only
Rear yard fences for lots 46, 47, 49, 50, 53, 54 – Wrought Iron or aluminum are required (see Exhibit B)
Rear yard fences for lots 44 – Shadowbox Only
Rear yard fences for lots 45, 48, 51, 52, 55 – Shadowbox or aluminum

- (b) Lots 44-55 (1-D) (pond lots) are required to maintain the landscaping to the waters edge, regardless of where the lot line ends.

4.2 Lakeview Lots (618-623 and 651-676)

Drainage/Swales/Erosion With respect to the established drainage pattern on any Lot, and as a part thereof, these restrictions hereby establish the following requirements which shall be observed and satisfied by each Lot Owner for his Lot, to wit:

- iv) All driveways and culverts shall comply with the mandates and directives of the Architectural Control Committee and shall be installed in accordance with the Engineer's specifications and standards and set at elevations required by the Architectural Control Committee and the Engineer. Each driveway culvert shall extend not less than two feet (2') beyond the edge of the concrete driveway. It is the responsibility of the Owner to install the culvert at the correct elevation. If the culvert is moved or is damaged during construction, it is the Owner's responsibility to replace or correct the culvert before pouring the concrete driveway. Failure to properly install a culvert shall authorize the Architectural Control Committee to replace and correct the culvert at Owner's expense. In addition to any other right or remedy in favor of the Developer, the Board of Directors or the Architectural Control Committee, the failure of the Owner to comply with this section shall authorize the Association to provide the necessary, work, labor, materials and maintenance necessary to bring the Lot/Lot Owner into compliance and charge the Owner responsible for the expense as an additional assessment owed by the Owner. In addition to the above, each Lot Owner shall comply with the required driveway culvert sizing as dictated by the Developer.

- v) Drainage swales are located in front of each lot within the street right of way. It is the lot owner's responsibility to sod and maintain the swales as to always maintain proper drainage. No plantings of any kind is allowed in the street right of ways without the prior approval of the Architectural Control Committee .

- vi) Culverts must be either corrugated metal or concrete.

- vii) Headwalls are required as per Exhibit D. Brick is to match brick on home.

V. LANDSCAPE REQUIREMENTS

5.2 Local Conditions

Attractive and well maintained Landscaping is vitally important to the quality image of high end neighborhoods and is especially important to the Bedico Creek Preserve. Specific focus is directed to soil conditions that can affect the success your landscape installation. Some of the project area was previously cleared, filled and is therefore without natural vegetation special care should be taken to apply soil amendments to add organic nutrients to the clay soils. All plant material installations needs a 50/50 ratio of native soils to a sandy organic planting mix. In addition the site is relatively flat and drainage must be accomplished by final shaping of your lot to catch basins via grass swales. The use of native plant materials is encouraged for drought tolerance, pest and disease resistance. Irrigation systems are highly recommended for vigorous plant

growth and persistent drought cycles. Local climatic conditions allow for trees, shrubs, ground covers and lawns to mature rapidly given proper selection and good care.

5.3 Landscape Design

Professional design is encouraged for all front yards. Widespread use of flowering trees, shrubs, perennials and annuals is desired. All areas of lots or sites not covered by buildings, drives, patios, pools or walks must be planted. All plant materials should be well formed, healthy and disease free when planted, irrigated, fertilized, pruned and otherwise maintained throughout their life.

5.4 Minimum Landscape Standards

A. The specific requirements listed below are minimum standards only.

Neighborhood	Min. Trees	Min. Shrubs	Min. Bed Area
Longview	1/2000 sf	30	10% of front yard
Preserve	1/2000 sf	35	10% of front yard
Lakeview	1/2000 sf	35	10% of front yard

B. Complete sodding of the front yard, and both street yards of corner lots, from the front elevation of the home to the curb of the street must be completed prior to occupancy. Sodding, sprigging or seeding of all other areas of the homesite must be completed upon occupancy, but not more than thirty days after occupancy. Certified centipede is suggested; however, the Committee may approve Bermuda, St. Augustine or Zoysia. Except for corner lots, side and rear yards may be sprigged or seeded.

C. **The entire front elevation of the home (on corner lots both street elevations) must be landscaped and home construction must be completed prior to occupancy by the homeowner.** If owner moves in or occupies the home prior to home completion or the completion of landscaping, the owner shall forfeit both Damage Deposit and Landscape Deposit. Further, liquidated damages will be assessed on the property at the rate of \$100 per day until the landscaping and/or home construction is completed. Further, the owner will be responsible for paying liquidated damages to the Committee or the Committee shall have the right to lien the property for the balance of said damages plus costs of litigation, attorney's fees and collection of same.

Exceptions to this will be if within two (2) weeks of move in, there are more than four (4) certified rain days (per Weather Bureau), then owner will be allowed the number of days over four (4) certified rain days, beyond move in day to complete landscaping. (e.g. If there are seven (7) rain days, the owner will be allowed three (3) days beyond move in to complete landscaping). Any days in excess of allowable days will result in damages of \$100 per day.

Sodding, sprigging or seeding of all other areas of the homesite must be completed upon occupancy, but not more than thirty days after occupancy.

Additionally, on homes which are on the Greenspace or any Common Area (such as, the jogging/ nature trail), all remaining landscaping must be completed within 60 days of home completion or occupancy. Refunds of deposits on homes on the Greenspace and Common areas are made after all landscaping both front and rear yards is complete. Landscape and Damage Deposits will be held until all phases of the landscaping are completed.

Builders of speculative homes must have the front elevation of the home landscaped by substantial completion of the home.

For all homes, all remaining landscape planting must be completed within one (1) year of occupancy.

The Recommended Plant Materials List below contains suggested plant materials recommended for your lot. These materials were chosen for their compatibility with both the St. Tammany climate and the overall design theme. Other trees, shrubs and ground covers may be used with the approval of the Committee.

RECOMMENDED PLANT MATERIALS

TREES: LARGE

Common Name	Botanical Name	Uses, Qualities and Remarks
Live Oak*	<i>Quercus virginiana</i>	Evergreen, broad spreading shade tree
Willow Oak*	<i>Quercus phellos</i>	Shade tree, fine texture
Southern Red Oak	<i>Quercus falcata</i>	Shade tree, red fall color
Cherry Bark Oak*	<i>Quercus falcata 'pagodifolia'</i>	Red fall color, long lived shade tree
Cow Oak*	<i>Quercus michauxii</i>	Shade tree, fall color
Southern Magnolia*	<i>Magnolia grandiflora</i>	Evergreen, fragrant white flowers
Cypress	<i>Taxodium distichum</i>	Fall color, waterside planting
Green Ash*	<i>Fraxinus pennsylvanica</i>	Fall color, excellent shade tree
Longleaf Pine*	<i>Pinus palustris</i>	Large evergreen
Slash Pine*	<i>Pinus Elliottii</i>	Evergreen
Tulip Tree	<i>Liriodendron tulipifera</i>	Good upright shade tree, fall color
Cottonwood*	<i>Populus deltoides</i>	Fastest growth shade tree
Lombardi Poplar	<i>Populus nigra 'Italica'</i>	Fast growth buffer tree, dry soils



TREES: MEDIUM

Common Name	Botanical Name	Uses, Qualities and Remarks
River Birch	<i>Betula nigra</i>	Interesting bark, yellow fall color, waterside planting
Swamp Red Maple*	<i>Acer rubrum 'Drummondii'</i>	Red flowers and fall color, waterside planting
Bradford Pear	<i>Pyrus Calleryana 'Bradford'</i>	Spring flowers, purple fall color

Chinese Elm	<i>Ulmus parvifolia</i>	Excellent patio tree, fine texture
American Holly	<i>Ilex opaca</i>	Evergreen, red berries, screen planting
Spruce Pine	<i>Pinus glabra</i>	Fine textured evergreen
Golden Rain Tree*	<i>Koelreuteria bipinnata</i>	Very fast growth, fall color, can freeze.
Weeping Willow	<i>Salix babylonica</i>	weeping form, waterside plant
Ginkgo*	<i>Ginkgo biloba</i>	Yellow fall color
Sweet Bay Magnolia	<i>Magnolia virginiana</i>	Flowering evergreen with striking silver color on underside of foliage
White Poplar	<i>Populus alba</i>	Fast growing salt tolerant shade tree

* Recommended for lots with no existing trees.



TREES: SMALL

Common Name	Botanical Name	Uses, Qualities and Remarks
Crape Myrtle	<i>Lagerstroemia indica</i>	Brilliant flower color, interesting bark, excellent patio or accent tree
Oriental Magnolia	<i>Magnolia Soulangeana</i>	Purple flowers, early bloomer, patio tree
Yaupon Holly	<i>Ilex vomitoria</i>	Evergreen, naturalistic plantings
Cherry Laurel	<i>Prunus caroliniana</i>	Evergreen, hedge and screen plantings, wildlife food

Sweet Olive	<i>Osmanthus fragrans</i>	Evergreen, fragrant flowers
Wax Myrtle	<i>Myrica cerifera</i>	Evergreen, screen and naturalistic plantings, wildlife food, waterside planting
Japanese Plum	<i>Eriobotrya japonica</i>	Wildlife food, coarse texture
Parasol Tree	<i>Firmiana simplex</i>	green trunks, coarse texture
Flowering Dogwood	<i>Cornus florida</i>	Flowering tree, fall color
White Fringe Tree	<i>Chionanthus virginicus</i>	Native flowering tree
Parsley Hawthorn	<i>Crataegus Marshallii</i>	Native flowering tree, fine texture detail design
Silver Bells	<i>Halesia diptera</i>	Native flowering tree, excellent for patio locations
Southern Crabapple	<i>Malus angustifolia</i>	Flowering tree, edible fruit



SHRUBS:

Common Name	Botanical Name	Uses, Qualities and Remarks
Hollies	<i>Ilex spp.</i>	Evergreen hedge, berries
Primrose Jasmine	<i>Jasminum Mesnyi</i>	Yellow flowers, spreading, pendulous form, screen
Nandina	<i>Nandina domestica</i>	Red berries and leaf color, accent plant
Red Tip Photinia	<i>Photinia glabra</i>	Large evergreen, red fallage color, screen and hedge plantings
Pittosporum	<i>Pittosporum tobira</i>	Large evergreen, fragrant flowers, screen
Indian Hawthorn	<i>Raphiolepis indica</i>	Low to medium evergreen shrub, pink or white flowers, very hardy

Dwarf Azalea	<i>Rhododendron obtusum</i>	Protected position, partial shade, brilliant flowers
Indian Azalea	<i>Rhododendron indica</i>	Large evergreen, partial shade, outstanding flowers, naturalistic planting
Camellia	<i>Camellia spp.</i>	Evergreen, flowering specimen
Gardenia	<i>Gardenia jasminoides</i> 'Prostrata'	Dwarf shade tolerant evergreen, fragrant summer flowers
Wax Leaf Ligustrum	<i>Ligustrum japonicum</i>	Excellent evergreen hedge
Sago Palm	<i>Cycas revoluta</i>	Course texture, accent
Abelia	<i>Abelia grandiflora</i>	Summer flowering evergreen
Fatsia	<i>Fatsia japonica</i>	Course texture shade plant, detail design for protected areas
Leucothoe	<i>Leucothoe axillaris</i>	Shade tolerant lowland plant
Star Bush	<i>Illicium floridanum</i>	Large understory flowering evergreen
Banana Tree	<i>Michelia Figo</i>	Evergreen, screen, fragrant flowers



VINES:

Common Name	Botanical Name	Uses, Qualities and Remarks
Carolina Yellow Jessamine	<i>Gelsemium sempervirens</i>	Semi-evergreen, fragrant yellow flowers
Confederate Jasmine	<i>Trachelospermum jasminoides</i>	Evergreen, fragrant white flowers
Lady Banksia Rose	<i>Rosa Banksiae</i>	Evergreen, climbing yellow flower
Wisteria	<i>Wisteria sinensis</i>	Fragrant blue-violet flowers, heavy, vigorous grower for garden structures
Fig Vine	<i>Ficus pumila</i>	Evergreen, popular wall covering
English Ivy	<i>Hedera Helix</i>	Shade tolerant evergreen, course texture
Fatsbedera	<i>Fatsbedera Lizei</i>	Shade tolerant evergreen, very course texture, detail design



GROUNDCOVERS:

Common Name	Botanical Name	Uses, Qualities and Remarks
Liriope	<i>Liriope Muscari</i>	Sun to shade, flower, border plant
Asian Jasmine	<i>Yuccelosperrnum asiaticum</i>	Sun to part shade, forms dense mat
Monkey Grass	<i>Ophiopogon japonicus</i>	Part shade to shade, fine texture, grass-like
Horizontal Juniper	<i>Juniperus horizontalis</i>	Full sun, dry conditions, fall color
Aspidistra	<i>Aspidistra elatior</i>	Deep shade, coarse texture
Louisiana Iris	<i>Iris 'Louisiana'</i>	Water side and naturalistic plantings, full range of flower color, detail design
Wood or Marsh Fern	<i>Dryopteris spp.</i>	Shady positions, moist soils, naturalistic plantings
Ajuga	<i>Ajuga reptans</i>	Shade tolerance, detail design, low growing
Cattails	<i>Typha latifolia</i>	Waterside planting
Horsetail	<i>Equisetum hyemale</i>	Waterside planting

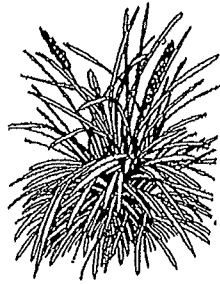

GRASS:

Common Name	Botanical Name	Uses, Qualities and Remarks
Centipede	<i>Erenochloa ophiuroides</i> 'Oaklawn'	Yellow green, medium coarse texture
Bermuda	<i>Cynodon Dactylon</i>	Dark blue-green, poor shade tolerance, fine texture
St. Augustine	<i>Stenotaphrum secundatum</i>	Dark blue-green, good shade tolerance, fine texture
Zoysia	<i>Zoysia spp.</i>	Dark green, extremely fine texture, good shade tolerance

**BEDICO CREEK PRESERVE
LONGVIEW, PRESERVE, LAKEVIEW, PRESERVE III NEIGHBORHOODS**

DESIGN REVIEW APPLICATION

DATE SUBMITTED _____ LOT # _____

OWNER'S NAME _____

OWNER'S ADDRESS _____

HOME PHONE _____ BUS PHONE _____ EMAIL _____

BUILDER _____ Phone/Email _____

ARCHITECT/DESIGNER _____ Phone/Email _____

CHECK ONE

To expedite approval process, please fill out form completely and accurately and submit with plans and required review fees and deposits (see instructions)

- Custom
- Preliminary Home Design
- Plan Change
- Speculative
- Final Home Design
- Approved Plan Change
- Fence
- Pool
- Addition/Modification

REVIEW FEES

Home Design Review Fee		Damage Deposit	
"Preferred" Builder	\$ 250	"Preferred" Builder	\$ 1,000
All other Builders	\$ 500	All other Builders	\$ 2,000
		Plan Change	\$ 100
Additional Review	\$ 100		
Pool Review	\$ 100		
Fence Review	\$ 50		

At the discretion of the ARC, and taking into consideration the builders past performance, a Select Builder, can be allowed one deposit for ALL jobs under construction.

Make checks payable to Bedico Creek Homeowner's Association

PLANS (ELECTRONIC) + SITE PLAN + REQUIRED FEES DEPOSITS ATTACHED

COMMITTEE ACTION

- APPROVED AS SUBMITTED
- APPROVED AS NOTED
- RESUBMIT
- OTHER

COMMENTS: _____

Approved By _____

Date _____

INSTRUCTIONS FOR DESIGN REVIEW

PLAN SUBMITTAL

Plan submittal must include the following:

- Completed Design Review Application
- 1 Electronic Set of Plans
- 1 Electronic copy of Site Plan
- Copy of check for the fees

Plans can be submitted through our password protected website:

Bedicohoa.com

Password: bhomeowner (all lower case)

Call 504-364-1370 for further details.

Email to: Kristi@cpmcnola.com

Questions: Kristi Pierson
504-364-1370 or email Kristi@cpmcnola.com

FEES:

MAIL TO: BEDICO CREEK PRESERVE PROPERTY OWNERS ASSN.
3520 HOLIDAY DRIVE, SUITE A,
NEW ORLEANS, LA 70114

Please include a copy of the review application with your payment.

EXHIBIT A

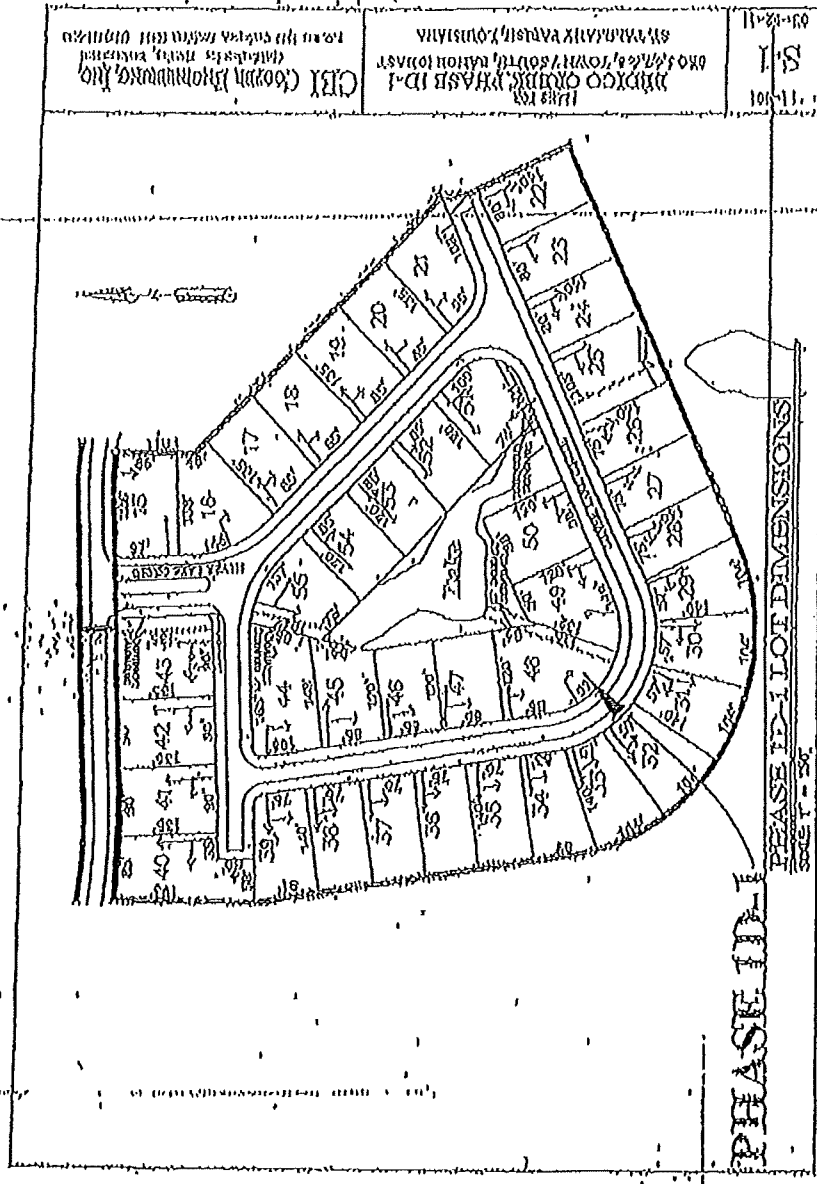

11-11-101
S.I.
09-12-11
MISSOURI
PHASE I-1
DRO 1/2 AC, 1/4 TOWN / SOUTH, EASTON TOWNSHIP
BY VANDAN VASTIN, ILLINOIS
CMI Group, Inc.
COLUMBIAN, MISSOURI
FROM THE OFFICE RECORDS OF THE COUNTY

PHASE I-1

PHASE I-1 LOT DIMENSIONS
SHEET - 30

EXHIBIT A

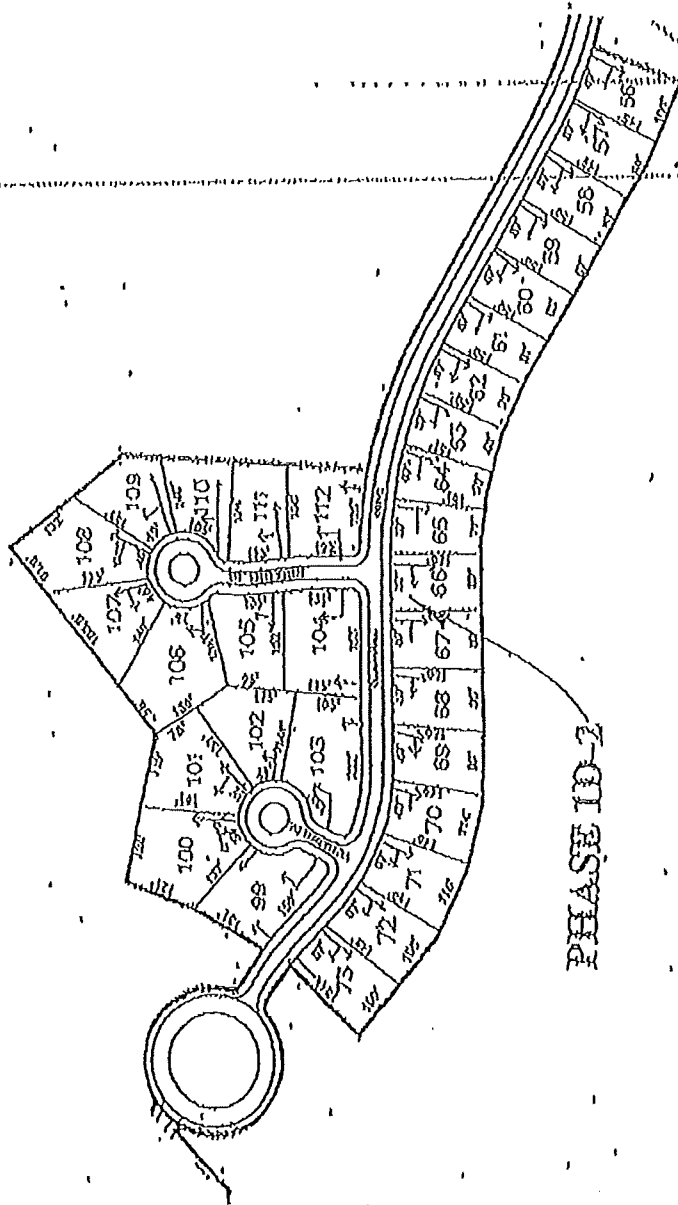

PLEASE ID-2

BEDICO CREEK PARCEL F,
SECTION 6, T-7-S, R-10-E,
GREENSBURG LAND DISTRICT,
ST. TAMMANY PARISH, LOUISIANA.

Exhibit A
Preserve III

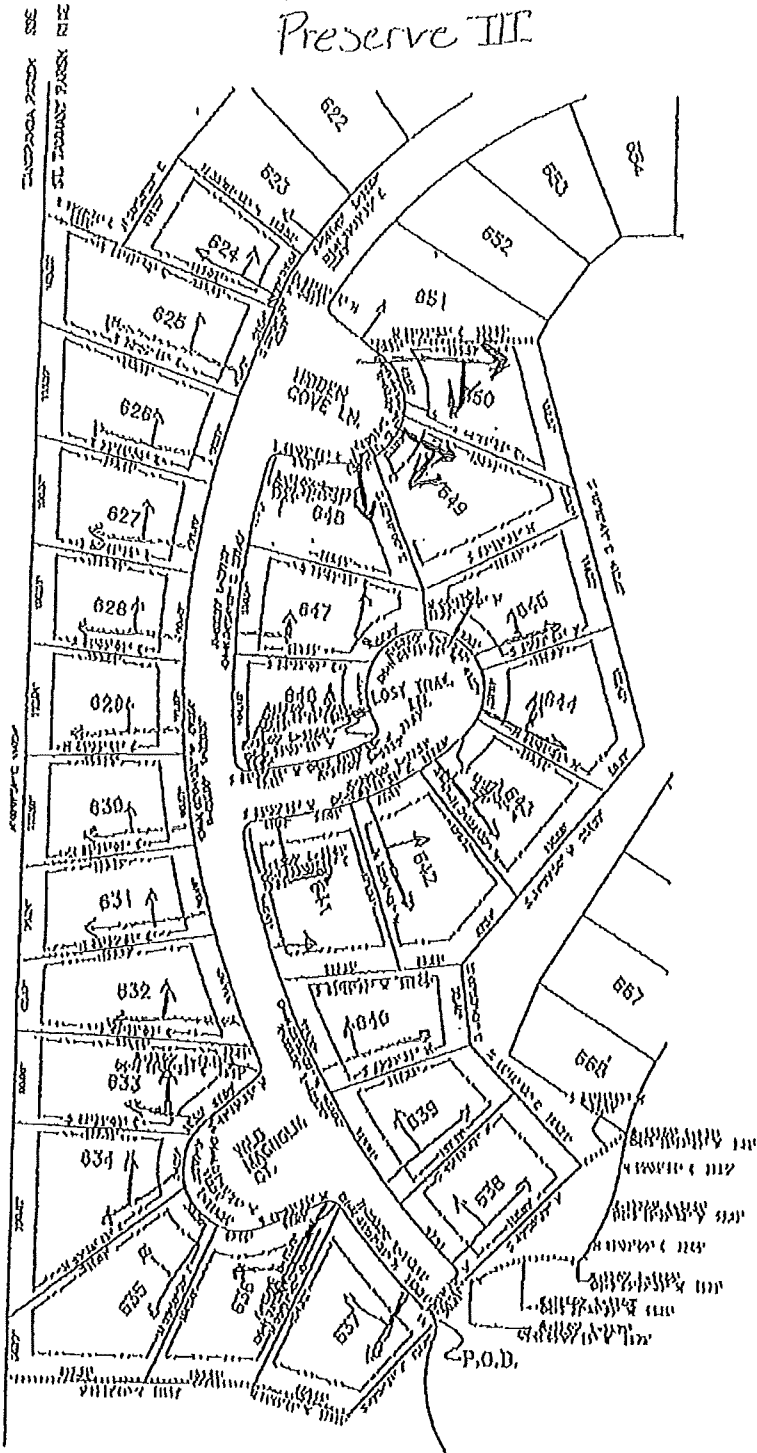

16000 BECHTEL
BIDCO CREEK PARCEL F

A certain parcel of certain plots in
Section 6, Township 7-S, Range 10-E,
Greenburg Land District, St. Tammany
Parish, Louisiana, as shown on plat
No. 11,200 of the public records of
this Parish, recorded in Book 53 &
Page 112 of the Public Records of
this Parish, is hereby divided into
lots as follows:

Lot 622, containing 0.1500 acre, or
1/6.67 of the whole, being the
southern portion of the parcel
described in the above plat, and
containing the same as shown on
the plat hereto annexed.

Lot 623, containing 0.1500 acre, or
1/6.67 of the whole, being the
southern portion of the parcel
described in the above plat, and
containing the same as shown on
the plat hereto annexed.

Lot 624, containing 0.1500 acre, or
1/6.67 of the whole, being the
southern portion of the parcel
described in the above plat, and
containing the same as shown on
the plat hereto annexed.

Lot 625, containing 0.1500 acre, or
1/6.67 of the whole, being the
southern portion of the parcel
described in the above plat, and
containing the same as shown on
the plat hereto annexed.

Lot 626, containing 0.1500 acre, or
1/6.67 of the whole, being the
southern portion of the parcel
described in the above plat, and
containing the same as shown on
the plat hereto annexed.

Lot 627, containing 0.1500 acre, or
1/6.67 of the whole, being the
southern portion of the parcel
described in the above plat, and
containing the same as shown on
the plat hereto annexed.

Lot 628, containing 0.1500 acre, or
1/6.67 of the whole, being the
southern portion of the parcel
described in the above plat, and
containing the same as shown on
the plat hereto annexed.

Lot 629, containing 0.1500 acre, or
1/6.67 of the whole, being the
southern portion of the parcel
described in the above plat, and
containing the same as shown on
the plat hereto annexed.

Lot 630, containing 0.1500 acre, or
1/6.67 of the whole, being the
southern portion of the parcel
described in the above plat, and
containing the same as shown on
the plat hereto annexed.

Lot 631, containing 0.1500 acre, or
1/6.67 of the whole, being the
southern portion of the parcel
described in the above plat, and
containing the same as shown on
the plat hereto annexed.

Lot 632, containing 0.1500 acre, or
1/6.67 of the whole, being the
southern portion of the parcel
described in the above plat, and
containing the same as shown on
the plat hereto annexed.

Lot 633, containing 0.1500 acre, or
1/6.67 of the whole, being the
southern portion of the parcel
described in the above plat, and
containing the same as shown on
the plat hereto annexed.

Lot 634, containing 0.1500 acre, or
1/6.67 of the whole, being the
southern portion of the parcel
described in the above plat, and
containing the same as shown on
the plat hereto annexed.

SECTION 9, TWP 13 N, R 10 W, S 11 E,
GREENSBURG LAND DISTRICT,
ST. TAMMANY PARISH, LOUISIANA.

EXIST A
Lake View

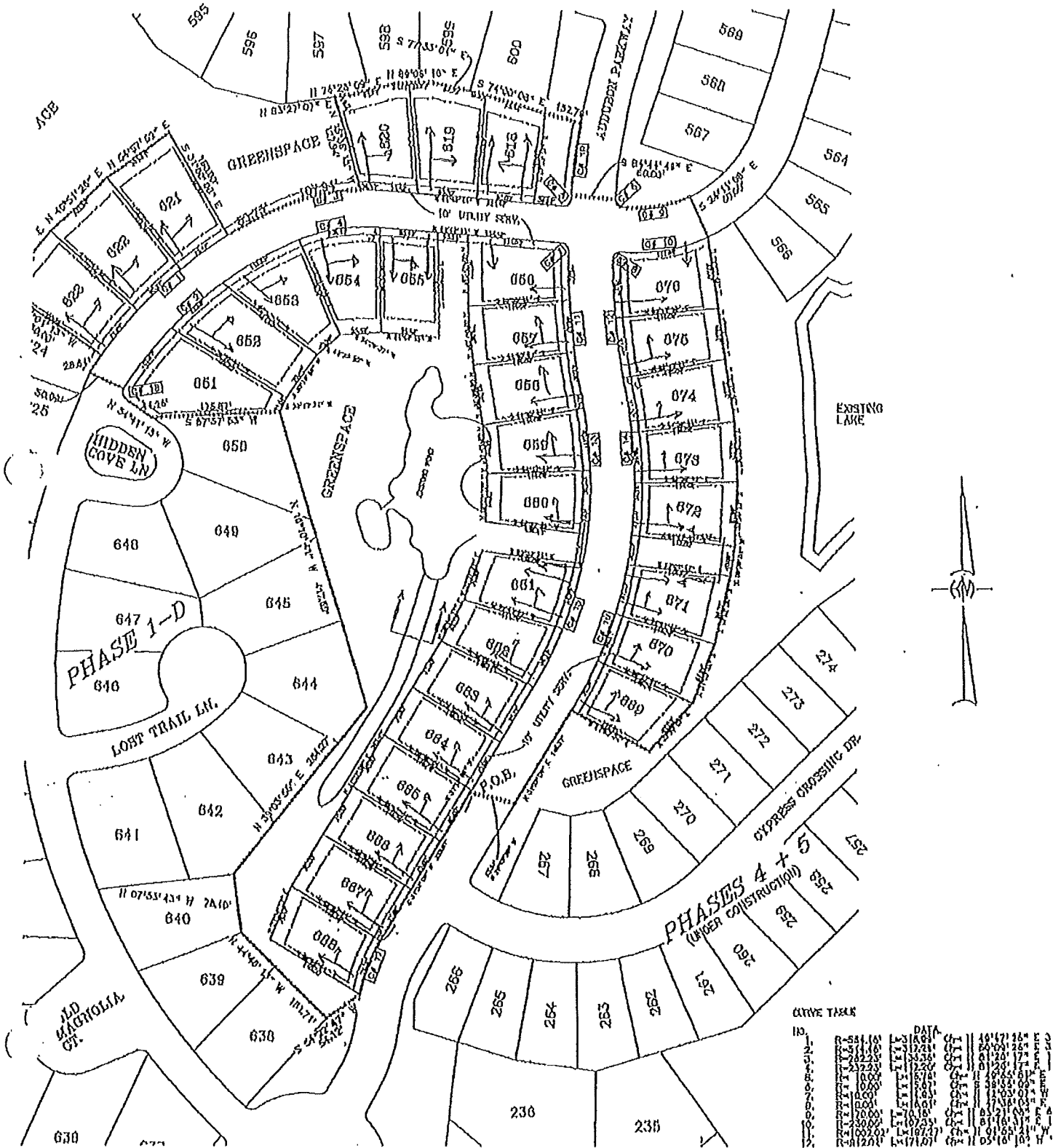

CURVE TABLE

NO.	DATA
1	11.171
2	11.171
3	11.171
4	11.171
5	11.171
6	11.171
7	11.171
8	11.171
9	11.171
10	11.171
11	11.171
12	11.171
13	11.171
14	11.171
15	11.171
16	11.171
17	11.171
18	11.171
19	11.171
20	11.171
21	11.171
22	11.171
23	11.171
24	11.171
25	11.171
26	11.171
27	11.171
28	11.171
29	11.171
30	11.171
31	11.171
32	11.171
33	11.171
34	11.171
35	11.171
36	11.171
37	11.171
38	11.171
39	11.171
40	11.171
41	11.171
42	11.171
43	11.171
44	11.171
45	11.171
46	11.171
47	11.171
48	11.171
49	11.171
50	11.171
51	11.171
52	11.171
53	11.171
54	11.171
55	11.171
56	11.171
57	11.171
58	11.171
59	11.171
60	11.171
61	11.171
62	11.171
63	11.171
64	11.171
65	11.171
66	11.171
67	11.171
68	11.171
69	11.171
70	11.171
71	11.171
72	11.171
73	11.171
74	11.171
75	11.171
76	11.171
77	11.171
78	11.171
79	11.171
80	11.171
81	11.171
82	11.171
83	11.171
84	11.171
85	11.171
86	11.171
87	11.171
88	11.171
89	11.171
90	11.171
91	11.171
92	11.171
93	11.171
94	11.171
95	11.171
96	11.171
97	11.171
98	11.171
99	11.171
100	11.171

EXHIBIT B

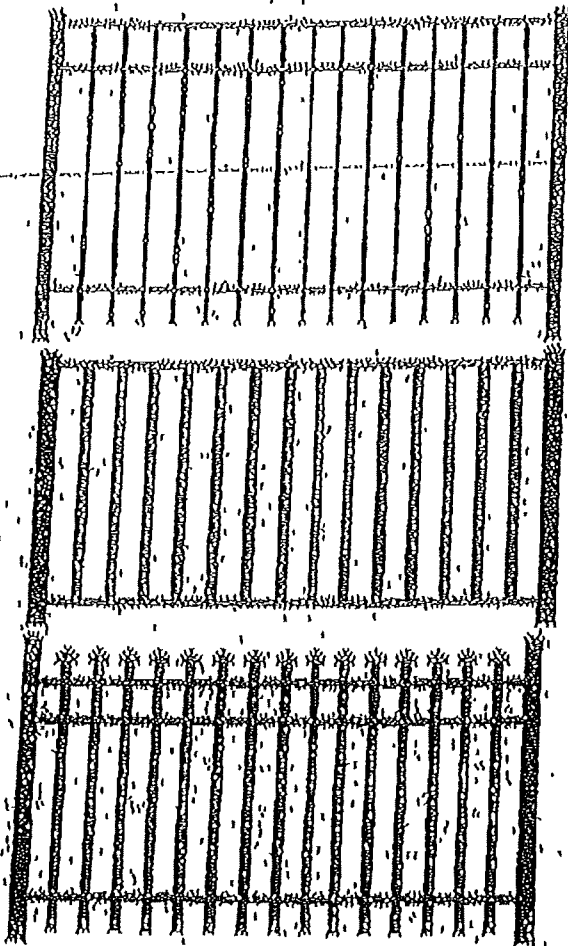
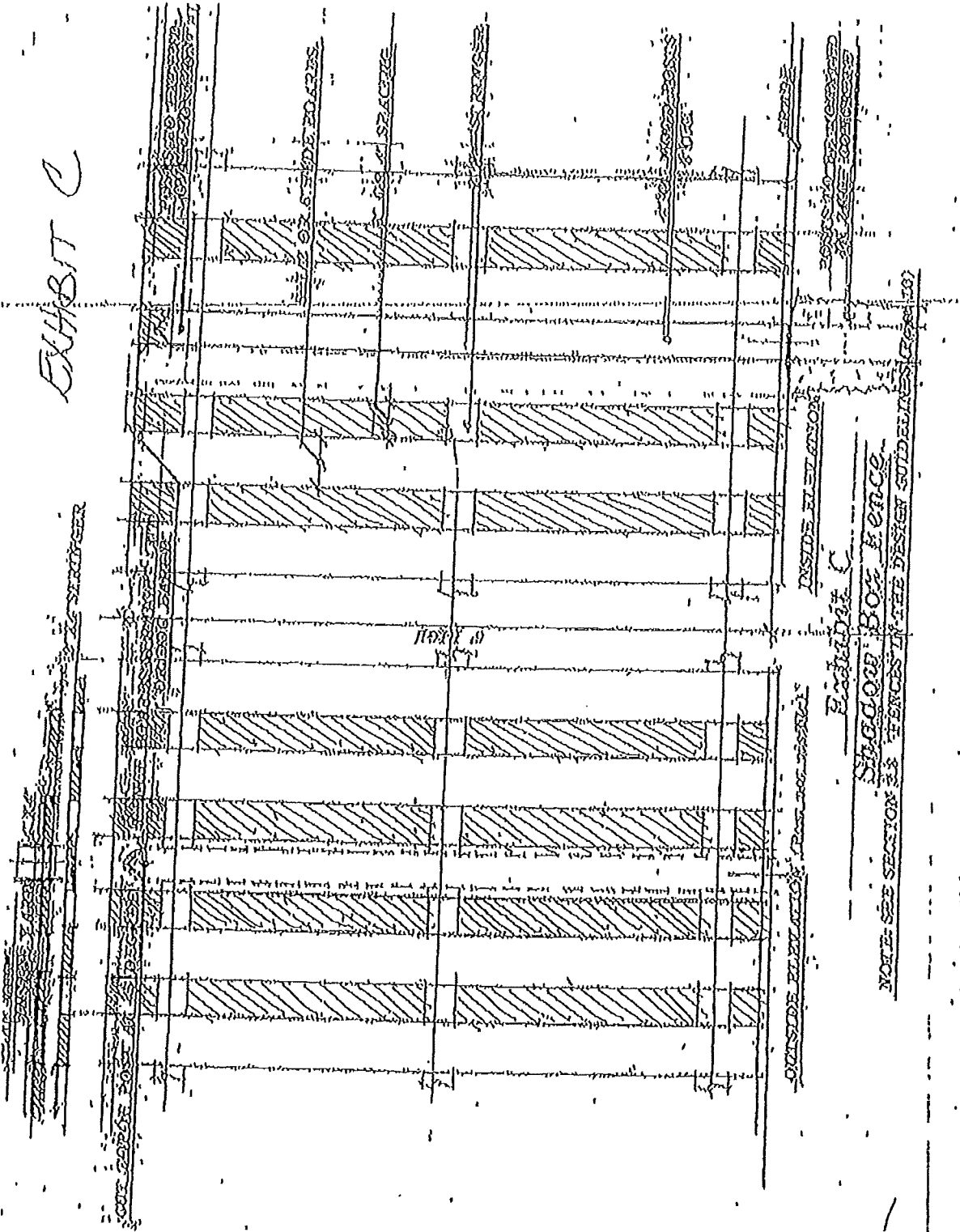

EXHIBIT C



INSIDE ELEVATION

EXHIBIT C

SHADOW BOX FENCE

NOTE: SEE SECTION 33 FENCES IN THE DESIGN SPECIFICATIONS (P. 10)

EXHIBIT D

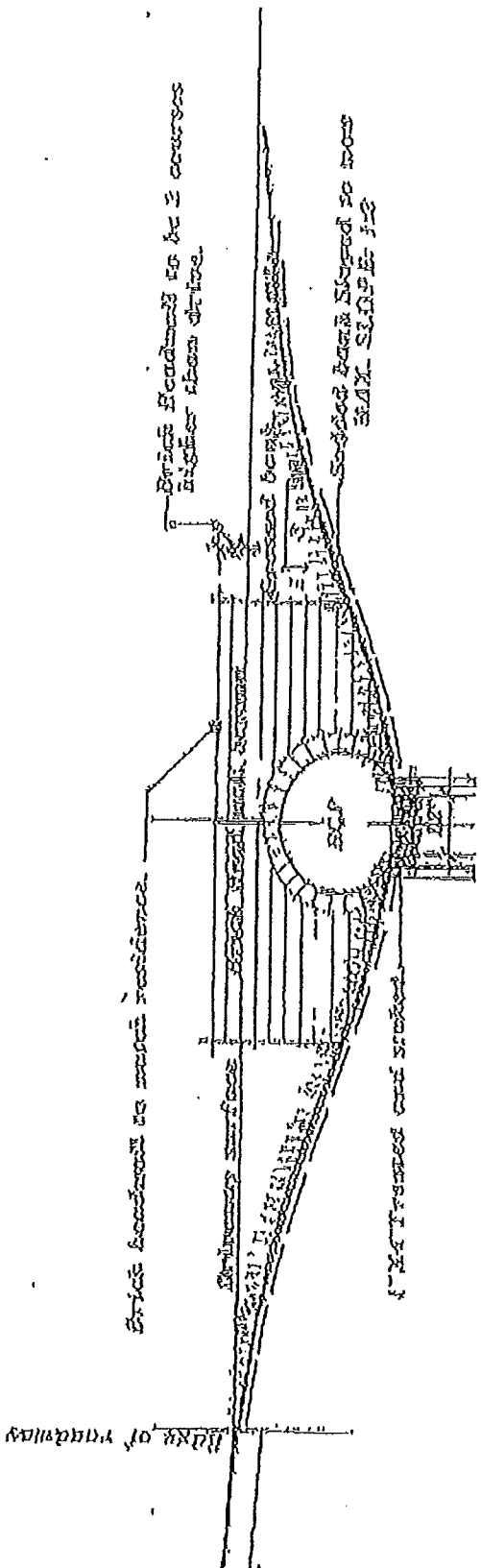

Typical Section/Elevation of Graced Spalls

NOTE: All drainage holes must be sealed.

Scale: 1/8" = 1'-0"

NOTE: Spalls within 100' of the pier to be graced with fewer than 300 lbs of steel reinforcement bars and additional seal treatments.

Exhibit D

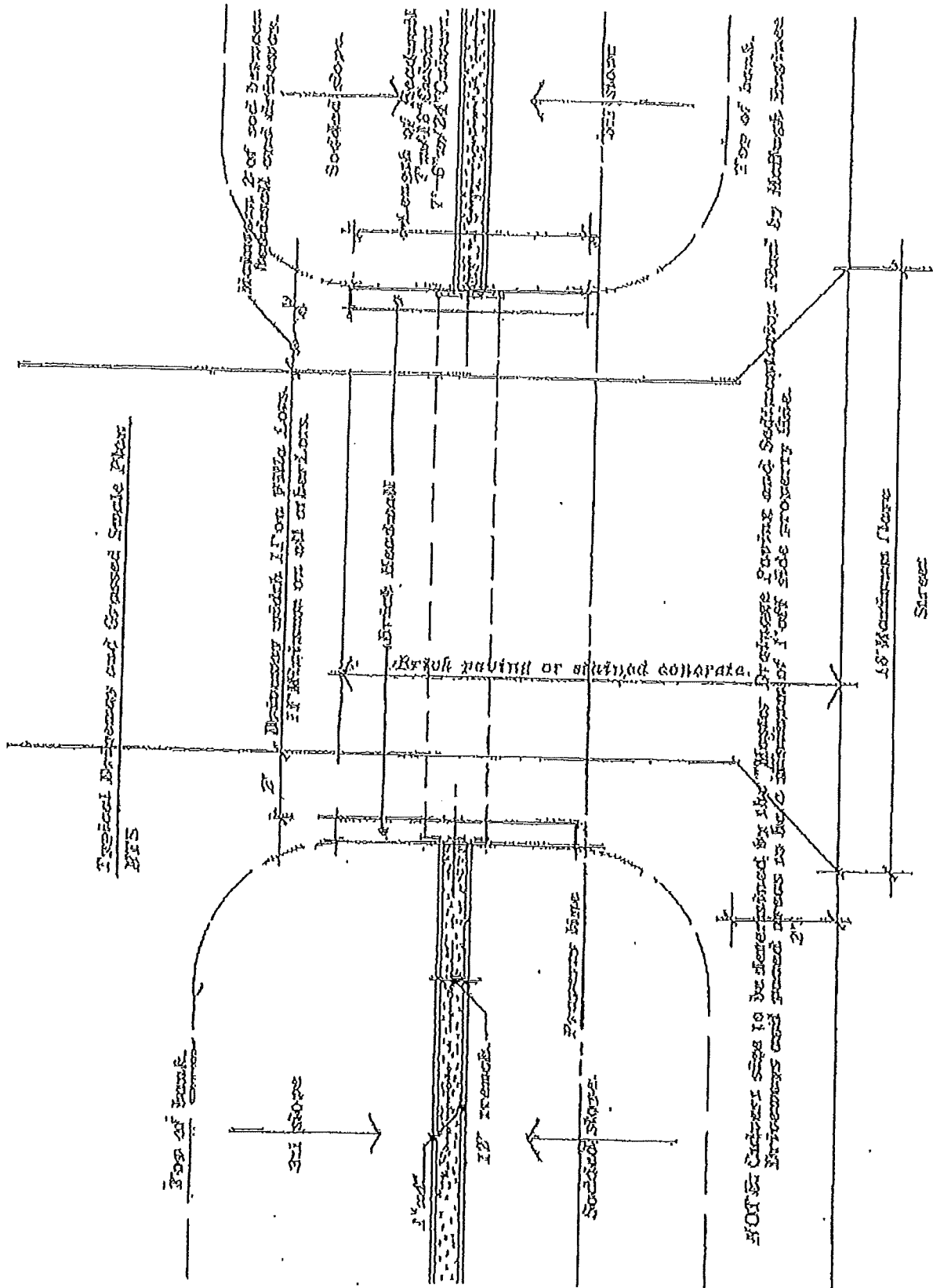

10/2/55

FOR CURBS TO BE DETERMINED BY THE HIGHWAY DEPARTMENT AND SETTLEMENTS MADE BY MUTUAL AGREEMENT BETWEEN THE HIGHWAY DEPARTMENT AND THE PROPERTY OWNER.